

0 603 400 037

Issue } 07-03-30  
Stand }

**Fig./Abb. 1**

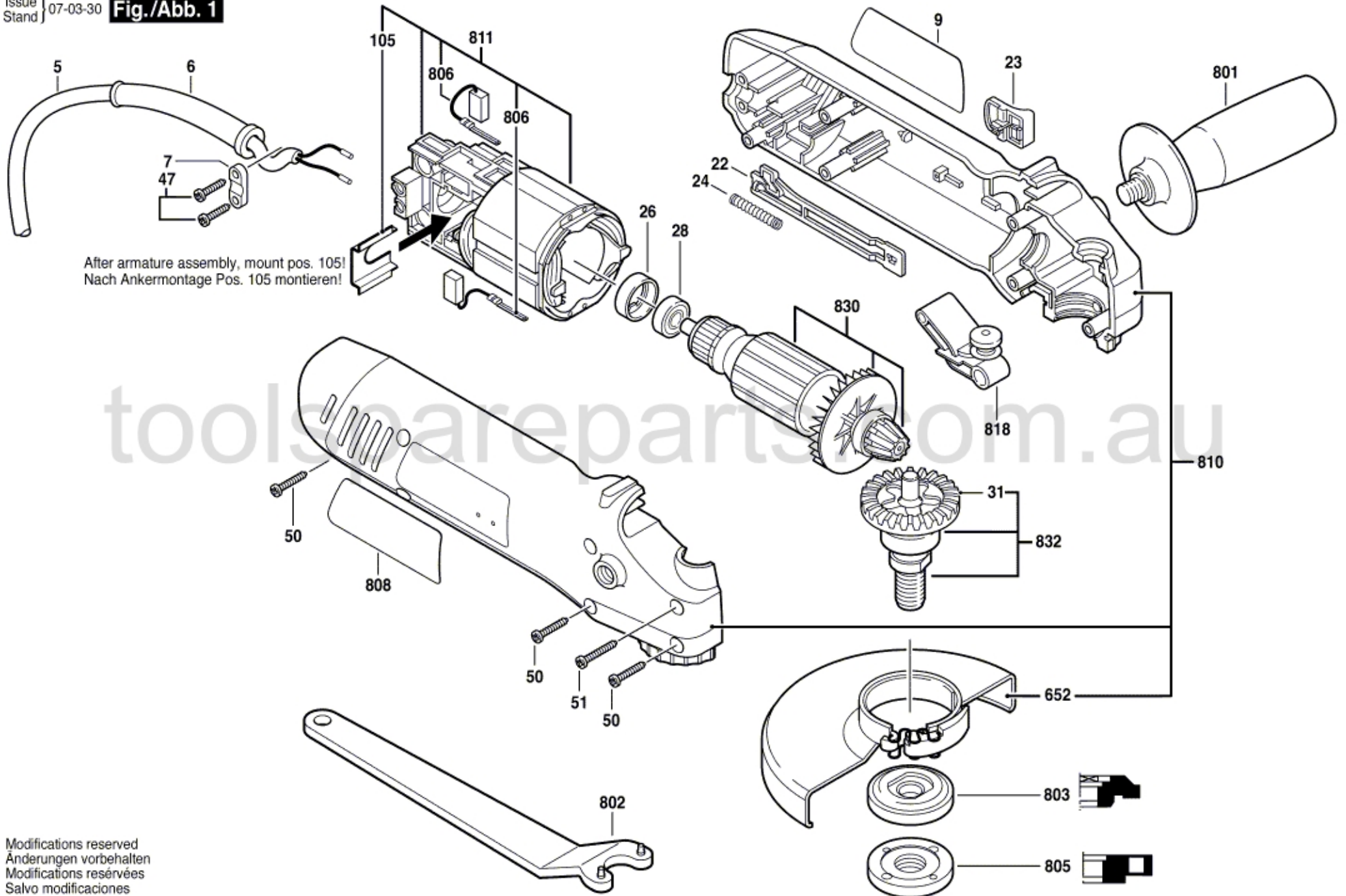

Modifications reserved  
Änderungen vorbehalten  
Modifications réservées  
Salvo modificaciones